

OCULUS | Keratograph 4

Topographer

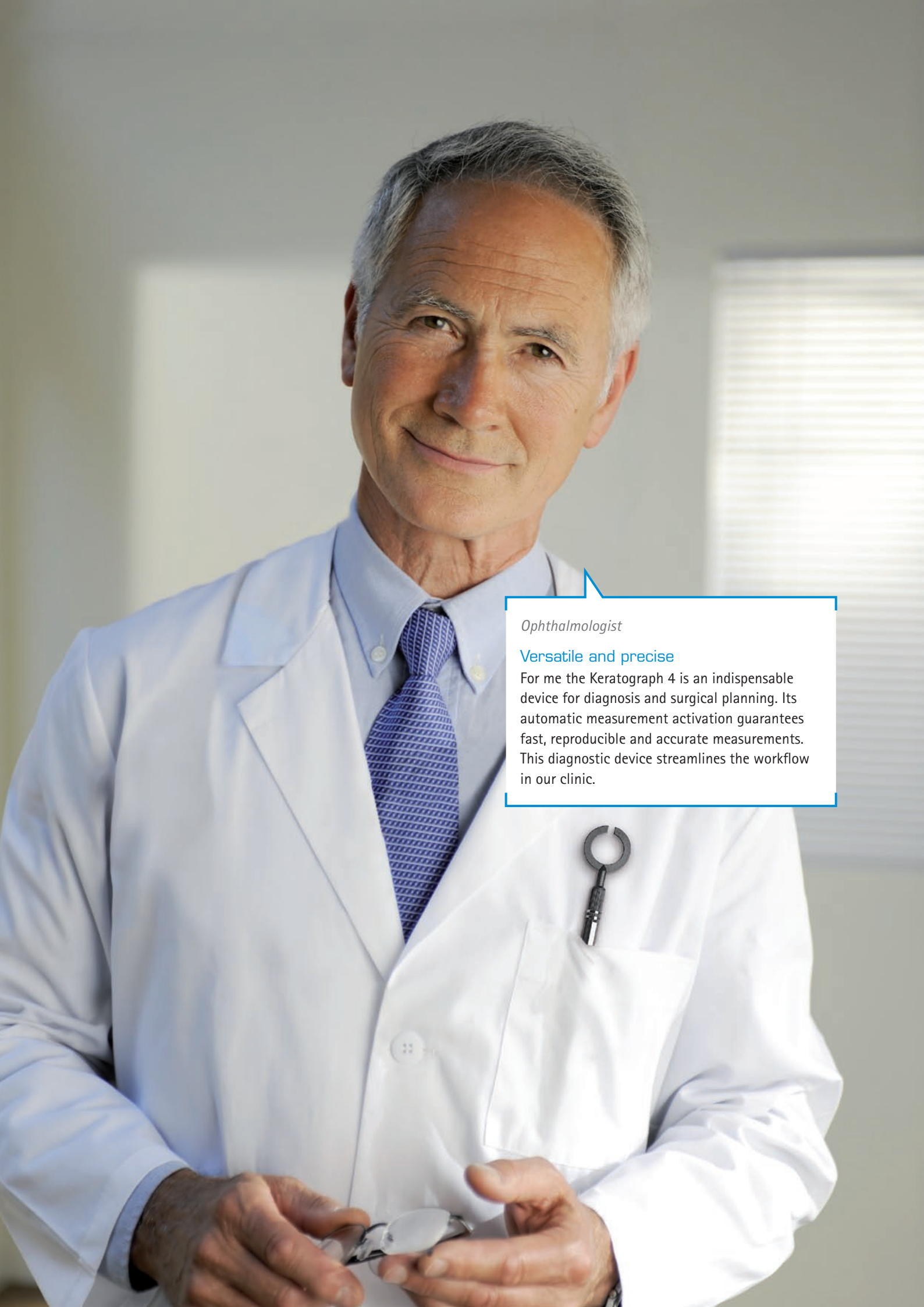

We focus on progress



Ophthalmologist

Versatile and precise

For me the Keratograph 4 is an indispensable device for diagnosis and surgical planning. Its automatic measurement activation guarantees fast, reproducible and accurate measurements. This diagnostic device streamlines the workflow in our clinic.

OCULUS Keratograph 4

From a measuring instrument to a consultation tool

Gold standard corneal topography – that's what the Keratograph 4 is all about. It ensures reliability when it comes to taking measurements, providing consultation and fitting contact lenses. The Keratograph accurate findings are something you can count on. The integrated keratometer and automatic measurement activation guarantee perfect reproducibility. In this way the Keratograph 4 also meets highest clinical standards for such procedures as tear film assessment and qualitative cornea analysis. It stands out by virtue of its versatility.



Taking measurements with placido ring illumination

The cornea is represented across its entire surface and globally using thousands of measuring points. Precise measurements form the basis for many modes of analysis and representation, such as, automatic keratoconus detection and 3D representation of the cornea.



Taking measurements with the blue light emitting diode

Previously you may have taken static fluo images and videos using the slit lamp – now you can also do so with the Keratograph 4! Use this function to examine the fit and mobility of contact lenses.

Precise measurements, comprehensible presentation – a picture says more than 1,000 words

Use the Keratograph 4 as a marketing tool and incorporate it actively into your consultations. With the Keratograph 4 software you can show images which your customers/patients have never seen before. Competent consultation (e.g. during follow-up exams) builds trust and forms the basis for intensive customer/patient loyalty. The Keratograph 4 – not only a measuring instrument but an ideal marketing tool.

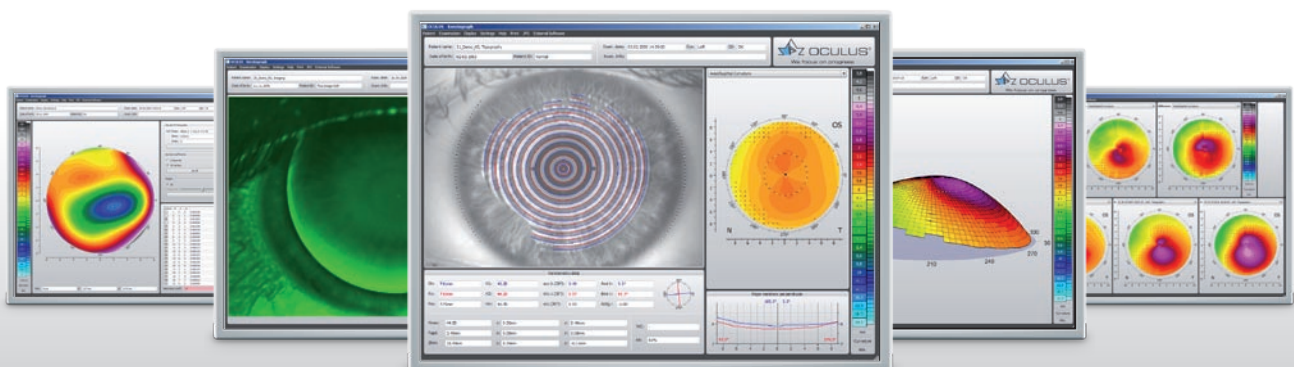

Diagnostics

Early detection is the key to preserve vision

> Non-contact, quick measurements

Hygiene and time management are important for any successful ophthalmic practice.

> Precise and reliable diagnosis and follow-up

With the Keratograph 4 accurate measurements, changes on the corneal surface can often be detected in the early stage. Follow-up exams over longer periods of time are equally important when you are dealing with changes in the cornea.

> Corneal surgery

The OCULUS Keratograph 4 provides reliable pre- and post-operative measurements.

> State-of-the-art Topography based keratoconus detection

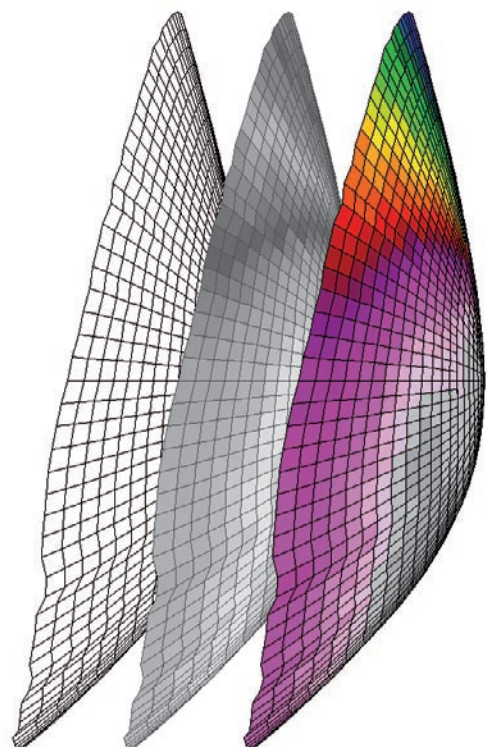
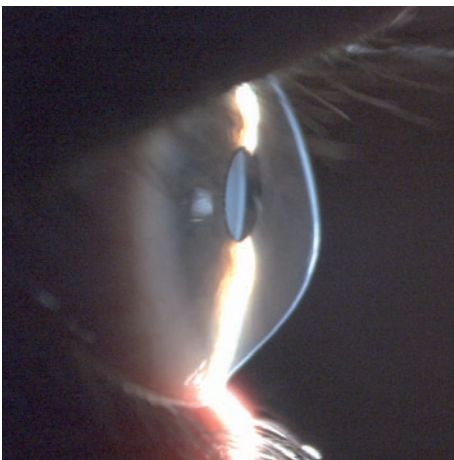

OCULUS Keratograph 4 – high-performance functionality, comprehensible representation.

Over 15 years of experience in assessing
topographic measurements.

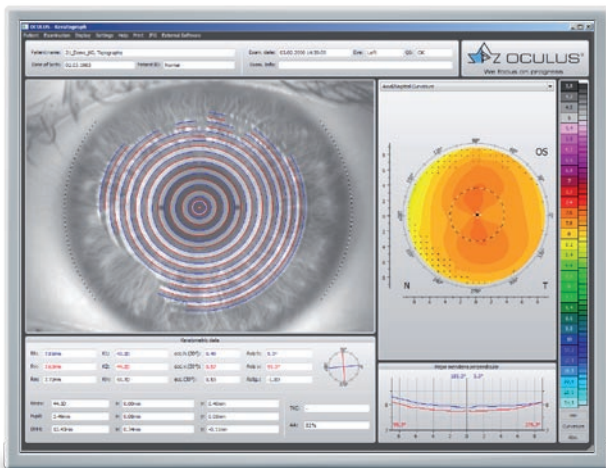

Overview display

The integrated keratometer guarantees highest measurement precision and reproducibility. After measurements have been taken, the comprehensive representation mode gives you a fast overview. Among other parameters, the central radii, K values, corneal astigmatism, eccentricity and corneal curvature are displayed. The color topographic representation depicts the curvature of the anterior segment of the cornea. Irregularities can be seen and measured on the camera image.

3D display

The 3D display depicts the curvature of the cornea. Any corneal astigmatism and irregularities can be demonstrated in an easy and comprehensible way. By swivelling and rotating the 3D map, the cornea can be viewed from various perspectives. Abnormalities can be displayed easily, which helps with patient/customer consultation.

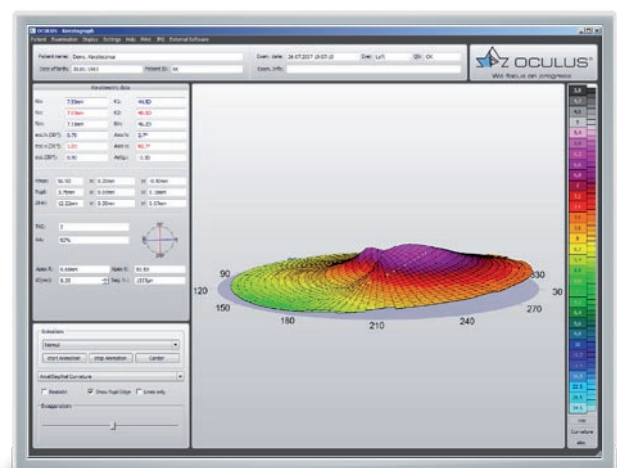

Fourier analysis

The Fourier analysis is an important tool for visualizing the amount of corneal irregularities. Using the Fourier analysis, the topography map is divided into individual components. The first three are standard components that represent lower order aberration and the fourth map shows the amount of corneal irregularities or higher order aberration.

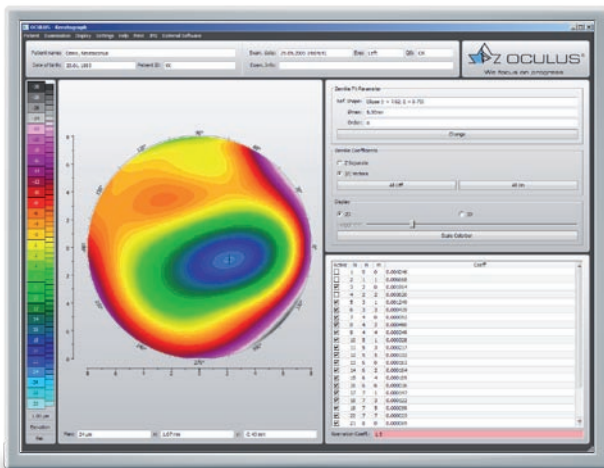
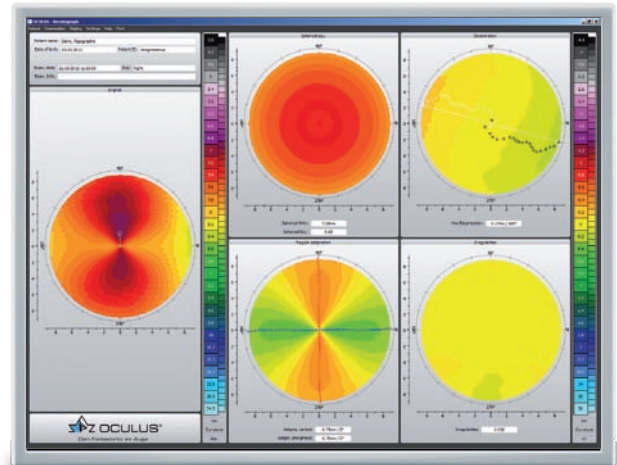

Zernike analysis

Irregularities of the cornea can be depicted clearly with Zernike analysis. If the given aberration coefficient is increased, this is an indication for deterioration of the eye's optical imaging quality. The exact location of the apex can also be identified easily using Zernike analysis. The location of the apex is marked with a black cross.

Indices

Using the "Indices" display, topographic abnormalities can be detected and diagnosed with ease. The measurements are compared with normative data. If deviations are found, the measurements are marked in yellow or red. On the basis of the measurements, a topographic classification is made. Abnormalities such as keratoconus can be detected in the early stage. If keratoconus is found, it is classified on the basis of the topographic data. The Indices display helps compare follow-up exams and shows whether an existing keratoconus remains in the same stage or progresses.

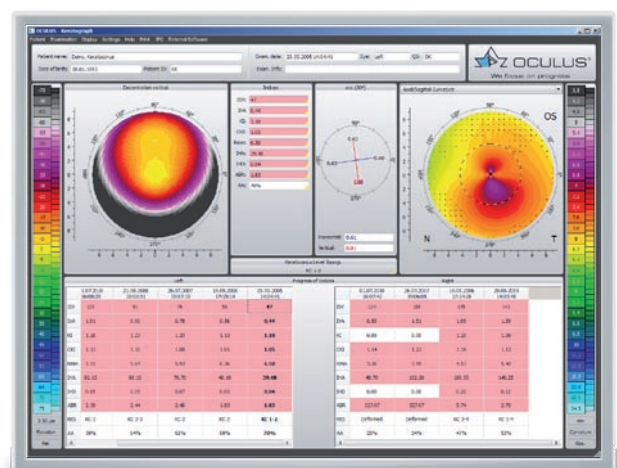

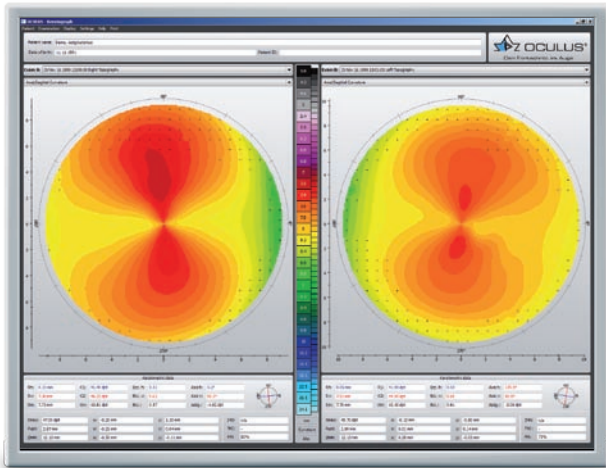

Show 2 exams

During the follow-up examinations, it is necessary to compare the results with the previous exams. With this feature you can compare the changes in the corneal topography over time for the contact lens wearers or patients with progressive conditions, such as Keratoconus.

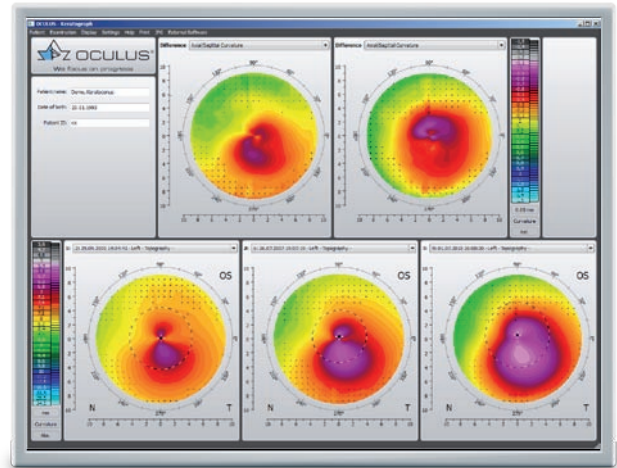

Compare 3 exams

With this feature, up to 3 examinations can be displayed and compared side-by-side. This is very useful for the follow-up examinations and to assess the progression or changes in the color maps.

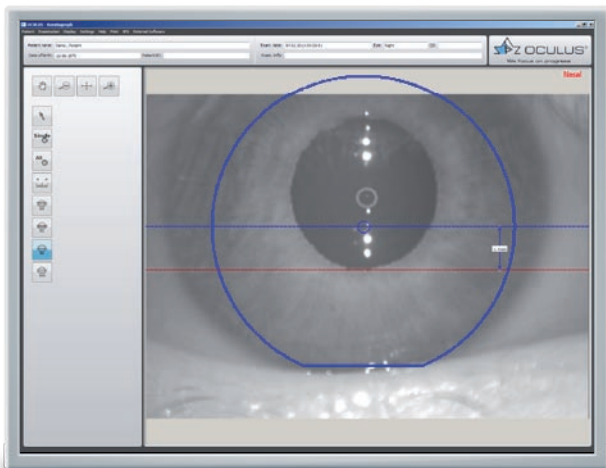

Near portion height measurement

This software precisely simulates the near portion height of rigid bifocal contact lenses and simplifies the complex fitting process.

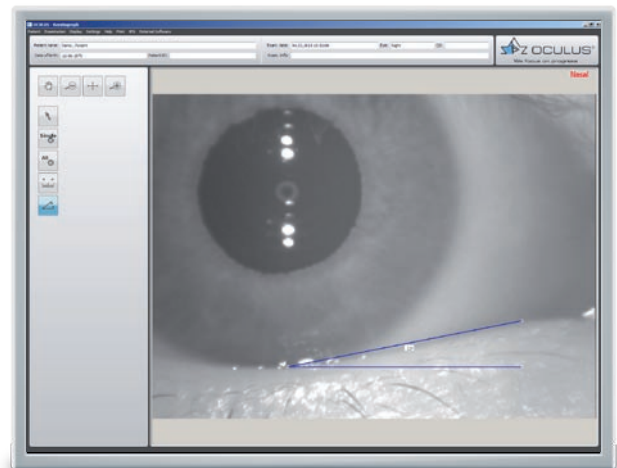

Palpebral angle measurement

The measurement of the nasal lower palpebral angle facilitates the identification of the expected inclination or stabilization axis when fitting toric contact lenses. Save time and money by giving this information to the contact lens manufacturer when you place an order.

TF-Scan makes the tear film visible

Patient consultation made easy. This software shows the **quality** and **quantity** of the tear film

In cases of dry eye patients and contact lens wearers, the tear film should be examined carefully. Only an intact tear film guarantees contact lens wearing comfort! The Keratograph 4 measures the tear film breakup time non-invasively (quality assessment). You can show your patient the individual tear film quality using the color maps. In addition, you can take another non-invasive measurement to determine the amount of tear film (tear film quantity).

Tear film quality (NIK BUT)

The OCULUS Keratograph 4 determines the break-up time using the NIKBUT procedure (non-invasive-Keratograph-break-up time).

Changes in the projected placido rings (displacement of margins of rings) give an indication of the break-up time of the tear film on the cornea.

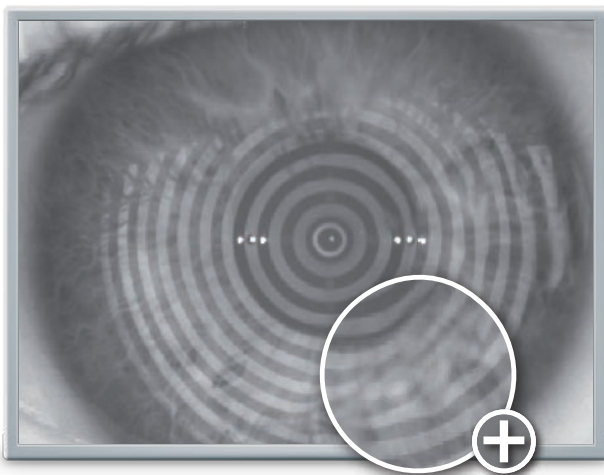

> Projection of the placido rings

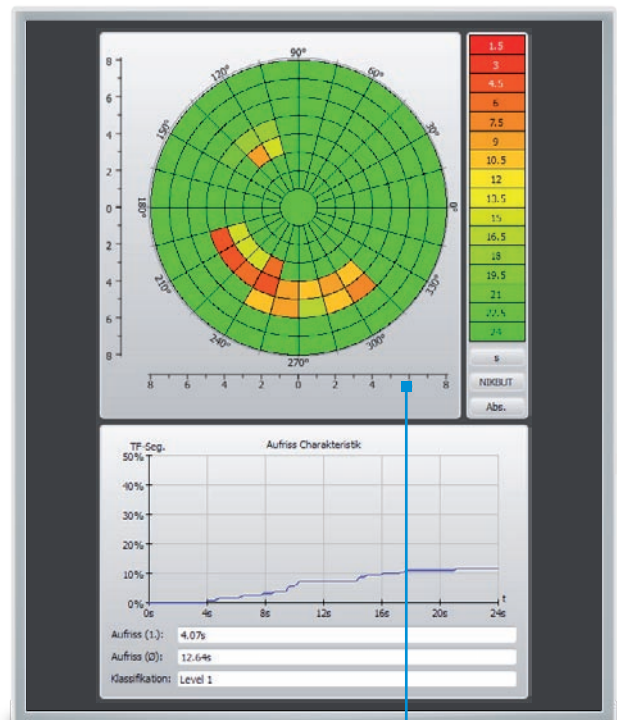

Consultation made easy – color assessment of break-up time

- green = stable tear film
- yellow = borderline tear film
- red = unstable tear film

Tear film quantity (tear meniscus)

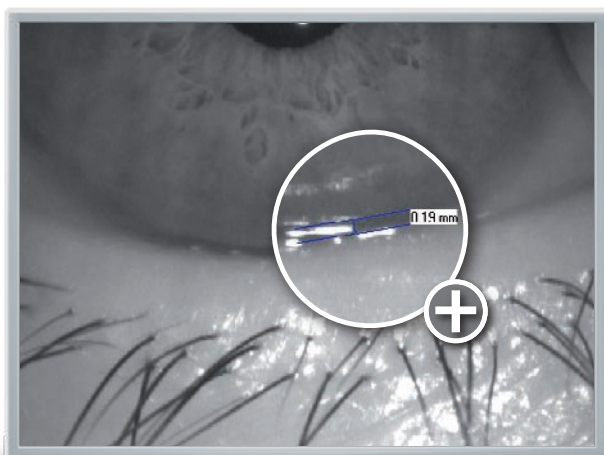

> Measure the tear meniscus height objectively with the OCULUS Keratograph 4.

OxiMap® – visualizing the oxygen transmissibility

Professional patient consultation

The cornea needs oxygen and a good oxygen supply is fundamental for the comfort of a contact lens wearer. New materials used for soft contact lenses offer excellent oxygen transmissibility. This can be shown with the new OCULUS OxiMap® display. You can easily show these color maps to your patients and help them choose better contact lenses.

How much oxygen really reaches the cornea?

Until now, only the oxygen transmissibility values for the center of a contact lens with -3.0 D were available. The OxiMap® shows the oxygen transmissibility depending on the lens material and the lens thickness. The OxiMap® is available for the most frequently sold spherical soft contact lenses. This impressive tool assists you in helping your patients select the most suitable contact lens.

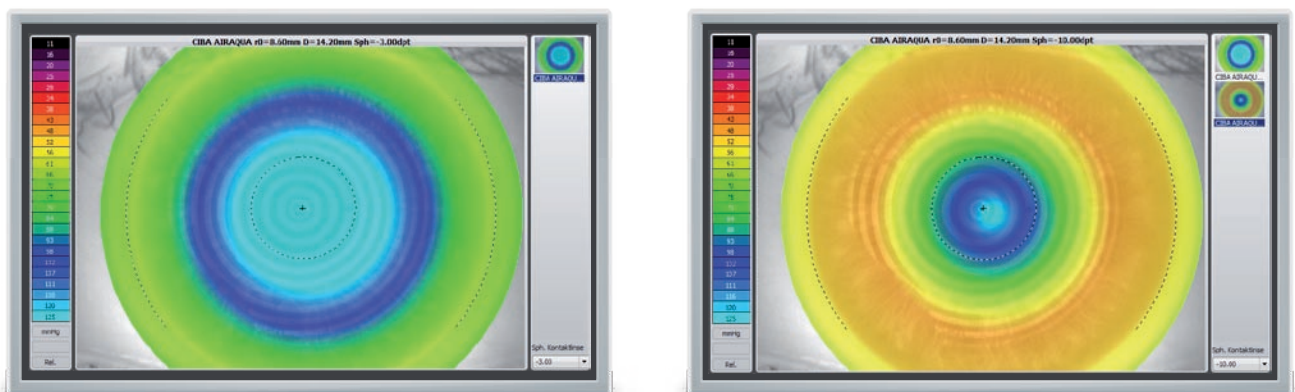

> Oxygen transmissibility for -3.00 D in comparison to the value for -10.00 D for identical type of contact lens

Plain and comprehensive visualization assures patient loyalty!

Contact lenses act as a potential barrier to oxygen transport even when the eyes are open to the atmosphere. Long hours of wearing comfort can only be guaranteed with a sufficient oxygen supply. The color representation of the various terms of oxygen transmissibility is based on international recommendations for daily, extended and continuous wear.

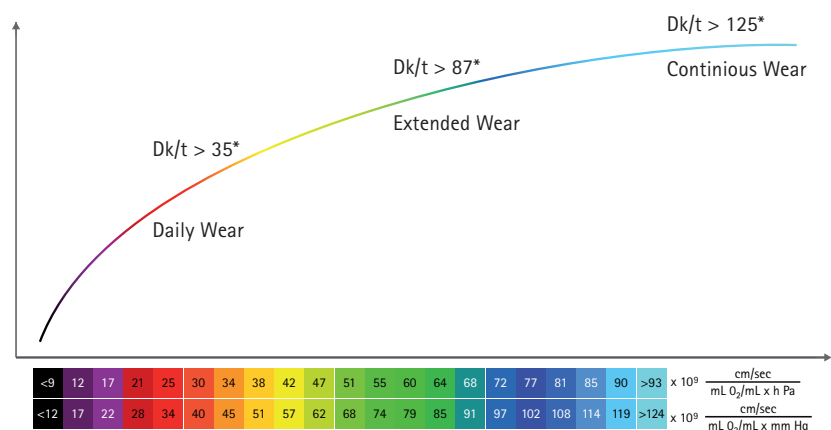

> The OxiMap® color coding of the Dk/T -values and the recommended wearing time

Fitting contact lenses

Professional contact lens fitting is an important expertise

> Fast, non contact measurements win customers over

The recorded data and the informative displays form the basis for a long term relationship.

> Every eye is different

Whether someone opts for soft or rigid contact lenses depends on many factors.

> Provide expert consultation

The large number of options for taking measurements and automatic assessments offer best prerequisites for professional contact lens fitting.



> *The high degree of wearing comfort afforded by professionally fitted contact lenses strengthens the customer/patient relationship significantly.*

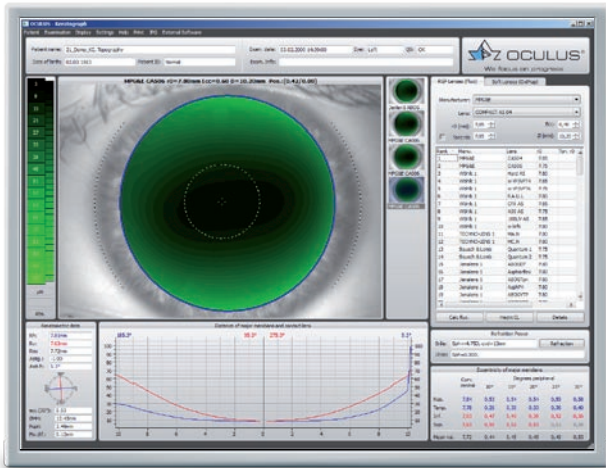

Contact lens fitting

Contact lenses are recommended on an individual basis and displayed in a list. In order to avoid taking more steps than necessary when fitting contact lenses, the fluo image can be simulated beforehand. The contact lens can be rotated and moved around. Fluo image simulation is adjusted automatically. The integrated and expandable database contains all customary types of contact lenses and is updated on a regular basis. The user can determine the order in which contact lens manufacturers appear.

Imaging

Using the "Imaging" option, real fluo images and videos are recorded – similar to the way images can be seen with a slitlamp using fluo drops. In this way you can check and demonstrate the fit and mobility of contact lenses to patients. All images and videos are saved automatically as well as the suggested fit of contact lenses.

The Keratograph 4 provides all prerequisites

- blue light emitting diodes in the illumination beam path
- a yellow filter in the observation beam path

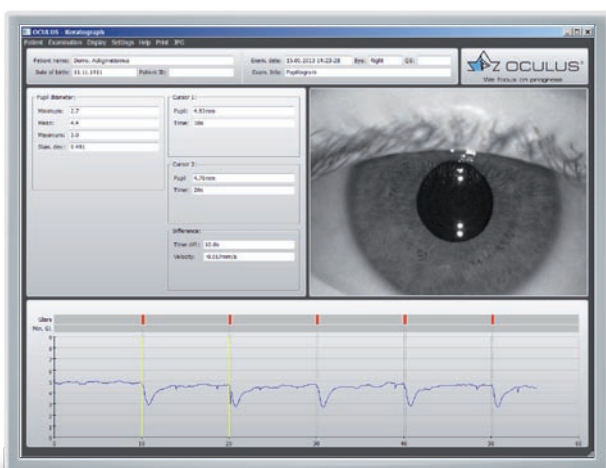
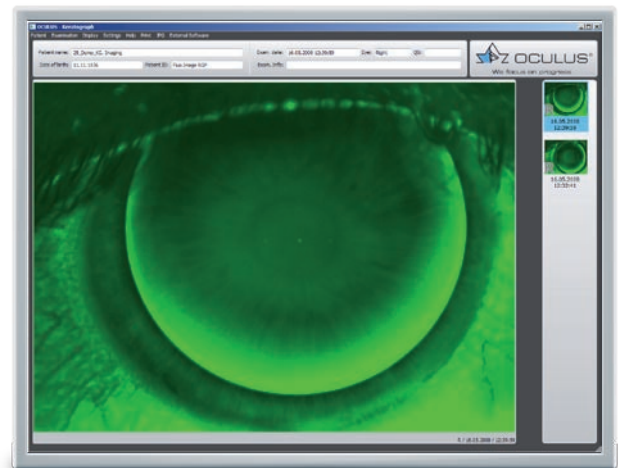

Pupillometry

Using the "Pupillometry" option, the reaction of the pupil, can be checked with and without blinding. This builds the basis for selecting the proper treatment zone for laser controlled surface ablation, multifocal contact lenses or premium IOLs. The pupil reaction of the two eyes can be compared.

Technical data

OCULUS Keratograph 4

Measurement range	3 – 38 mm, 9 – 99 D		
Precision	+/- 0.1 D		
Reproducibility	+/- 0.1 D		
Number of rings	22		
Working distance	80 mm		
Number of measuring points	22,000		
Camera	digital CCD camera		
Source of illumination	placido illumination:	red	650 nm
	imaging illumination:	blue	465 nm (UV-free)
	pupillometer illumination:	infrared	880 nm
Dimensions (H x W x D)	49 – 51.7 x 27.5 x 32 – 40 cm		
Weight	15 lbs.		
Power supply	100–240 VAC, 50–60 Hz		
Minimum PC requirements	Pentium IV 2.0 GHz, Windows XP, Windows Vista, Windows 7, 1 GB RAM, graphic card 1.024 x 768 pixels, USB connection		

CE in accordance with Medical Device Directive 93/42/EEC

uniqu**vision**

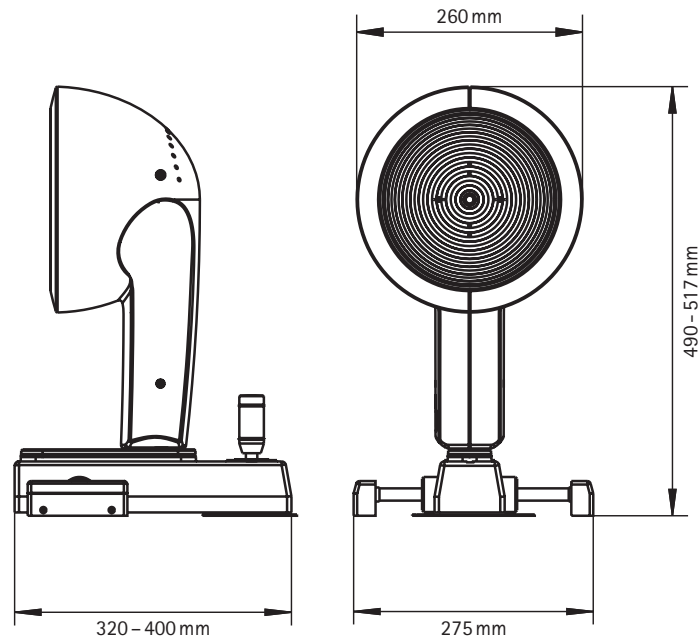

WWW.OCULUS.DE



OCULUS is certified by TÜV according to
DIN EN ISO 13485/DIN EN ISO 9001

OCULUS Optikgeräte GmbH
Postfach • 35549 Wetzlar • GERMANY
Tel. +49-641-2005-0 • Fax +49-641-2005-295
E-Mail: export@oculus.de • www.oculus.de

- OCULUS USA, sales@oculususa.com
- OCULUS Asia, info@oculus.hk
- OCULUS Czechia, oculus@oculus.cz
- OCULUS Iberia, info@oculus.es