

# OCULUS Easygraph

So Small and Yet a Topographer

## Small, but Efficient As a Big One

Wanting to work with a video keratometer in spite of limited space? Then the OCULUS Easygraph is what you're looking for. Equipped with proven measurement and device technology for contact lens fitting as well as precise and reliable diagnostics, the Easygraph has all it takes to be a real topographer, and one worthy of its "big brother", the OCULUS Keratograph.

## All Important Parameters at a Glance

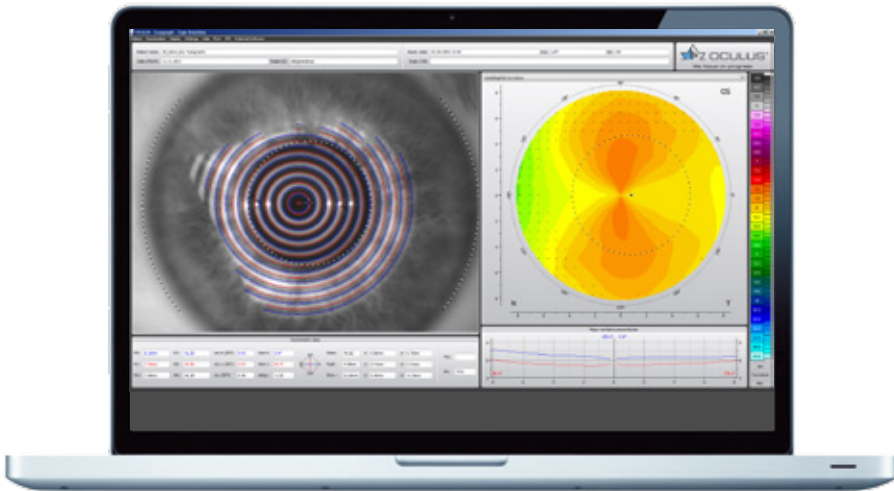

## Easy to Adapt

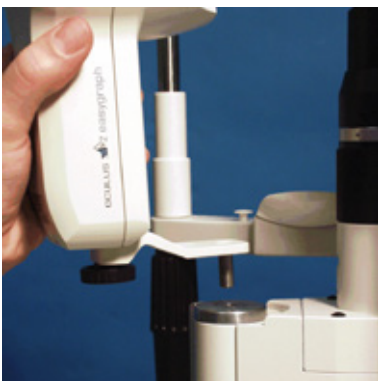

The Easygraph can be easily attached to any conventional slit lamp with minimum additional space requirements and positioned for quick, automatic measurements without touching the eye.

The OCULUS Easygraph in life size



# Technical Data

## OCULUS Easygraph

General information	
Accuracy	± 0.2 D
Reproducibility	± 0.2 D
Number of rings	22
Working distance	40 mm (1.6 in)
Number of measurement points	22,000
Technical specifications	
Dimensions (W x D x H)	119 x 102 x 216 mm (4.7 x 4.0 x 8.5 in)
Weight	0,73 kg (1.6 lbs)
Voltage	100–240 V
Frequency	50–60 Hz
Recommended computer specifications	800 G, Intel Core i5-4670, 3,4 GHz, 500 GB, 8 GB, Windows 8.1 Pro 64-Bit downgrade Windows 7 Pro 64-Bit

CE in accordance with Medical Device Directive 93/42/EEC

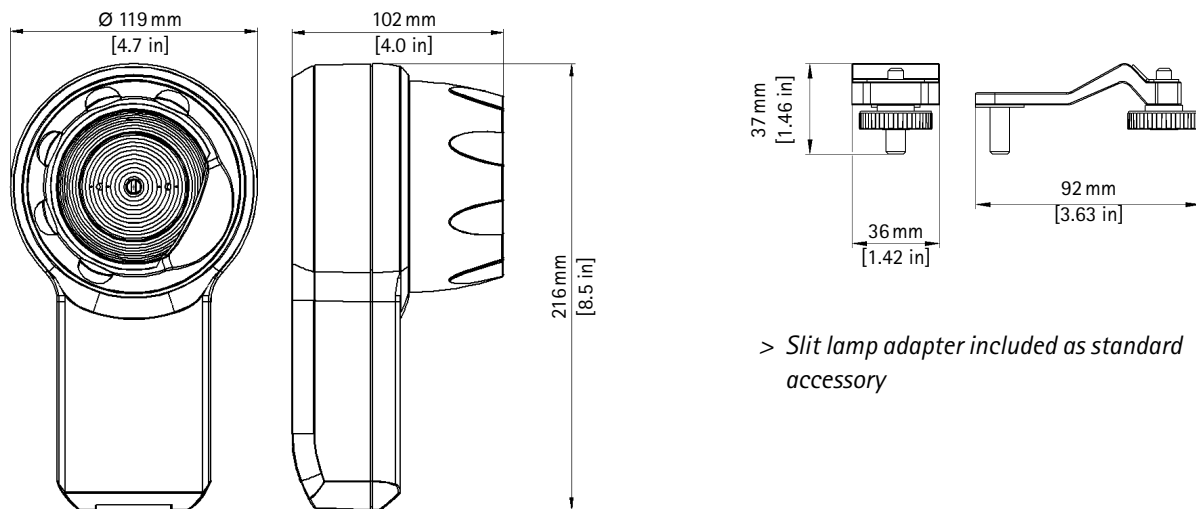

WWW.OCULUS.DE



OCULUS is certified by TÜV according to DIN EN ISO 13485

OCULUS Optikgeräte GmbH

Postfach • 35549 Wetzlar • GERMANY  
 Tel. +49-641-2005-0 • Fax +49-641-2005-295  
 Email: export@oculus.de • www.oculus.de

- OCULUS USA, sales@oculususa.com
- OCULUS Asia, info@oculus.hk
- OCULUS Czechia, oculus@oculus.cz
- OCULUS Iberia, info@oculus.es
- OCULUS Poland, biuro@oculus.pl
- OCULUS Turkey, info@oculus-turkey.com.tr



OCULUS | Easygraph

Topographer



# The Compact Corneal Topographer at a Glance

- Corneal topographer with built-in keratometer
- Comfortable, hygienic working distance reduces the influence of positioning tolerances
- Quick 3D alignment with auto-release to ensure highest accuracy and repeatability
- Sagittal (axial) and tangential (local) curvature [mm] and power [D] maps
- Refractive power map using Snell's law of refraction
- Elevation maps
- Zernike and Fourier Analysis
- Cornea diameter (HWTW)
- Comparison display and big camera image
- Easy to mount on any conventional slit lamp
- Easy to use sophisticated user interface in Windows™ environment
- USB interface to PC/Laptop with network compatible software

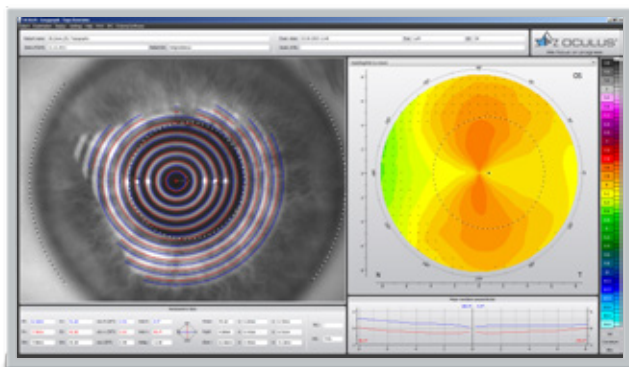

## Overview and 3D Display

The overview display shows different evaluations which together provide a quick overview of corneal topography. The coloured topography map describes the corneal curvature of the anterior surface. The measured local radii of curvature are displayed in colour. Abnormalities can be measured directly in the camera image. Important results such as central radii, corneal astigmatism, corneal diameter and eccentricity are displayed automatically.

## Compare Different Examinations

Regular follow-up examinations are essential for ophthalmologists as well as contact lens fitters. The Easygraph has three different displays for comparing examinations over time, making it easier to detect corneal changes or abnormalities (e.g. keratoconus). In addition the displays show changes in corneal refractive power and allow documentation of refractive changes brought about by refractive surgery or from wearing Ortho-K lenses.

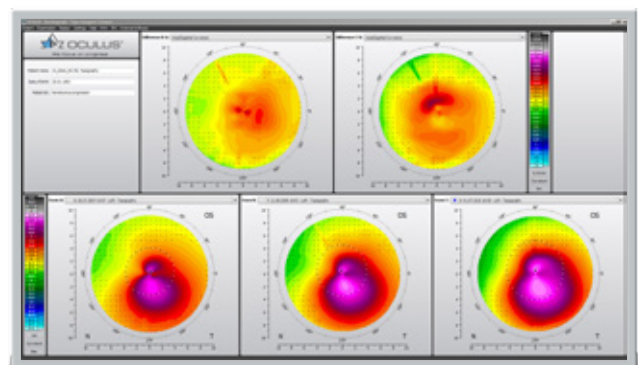



# Small but Perfect

Optional Software Extensions at a Glance

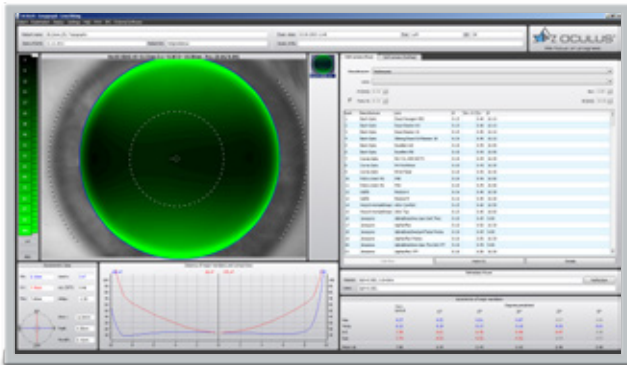

## Contact Lens Fitting

### Applications:

- Immediate suggestion of the best contact lens fitting
- Large pre-programmed and expandable contact lens database
- Real fluorescein image simulation
- Reduced chair time
- Refractive comparison module for Ortho-K lenses

### Details:

The contact lens fitting module suggests the best fitting contact lens. Different contact lenses types and geometries can be compared using fluorescein image simulation. Moreover the refractive comparison module helps in selecting Ortho-K lenses as well as objectively monitoring corneal refractive power changes.

## OxiMap® – Visualising Oxygen Transmissibility for Professional Patient Consultation.

The cornea needs oxygen, and a good oxygen supply is therefore fundamental for the comfort of contact lens wearers. New materials used for soft contact lenses offer excellent oxygen transmissibility. This can be demonstrated using the OCULUS OxiMap® display. You can easily show these colour maps to your patients in order to better explain them your contact lens recommendations. OxiMap® shows the oxygen transmissibility of contact lenses on a colour scale to depict the current international recommendations for daily, extended and continuous wear.

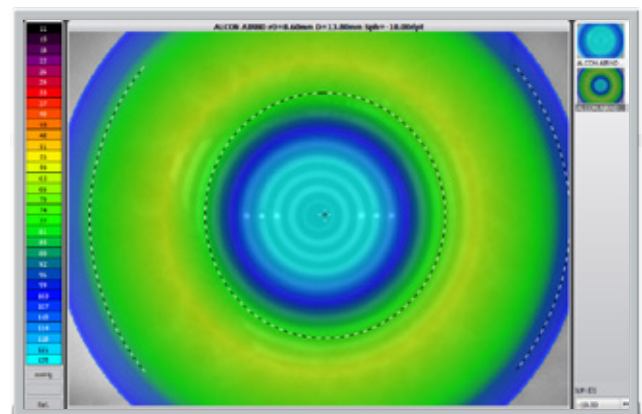
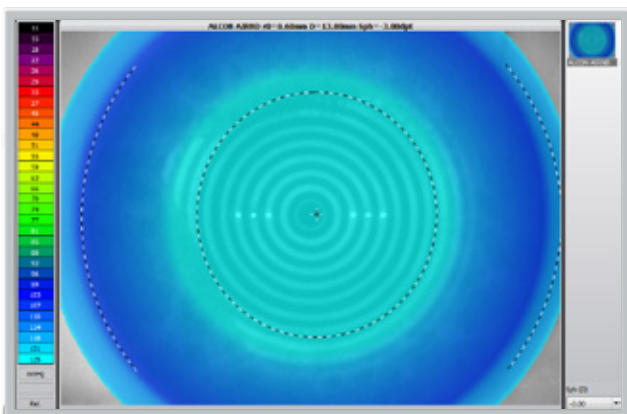

> Oxygen transmissibility of -3.00 D and -10.00 D contact lenses of identical type

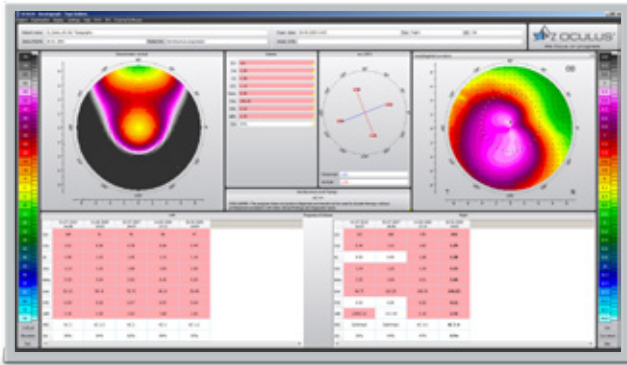

## Keratoconus Screening

Eight different indices are calculated based on an analysis of the anterior corneal surface. Keratoconus suspects as well as advanced keratoconus stages are detected and classified. Side-by-side presentation of different examinations facilitates follow-up.

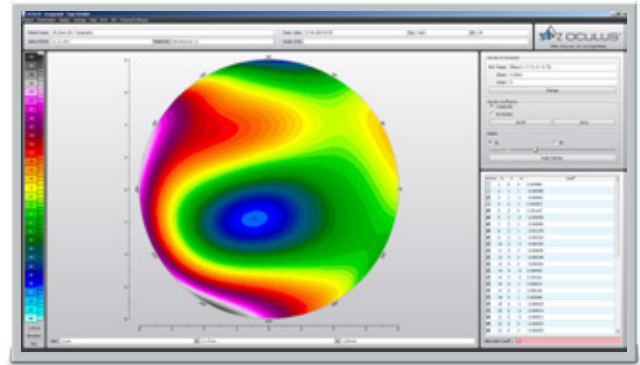

## Zernike Analysis

Zernike Analysis provides a means of describing irregularities of the cornea precisely. An elevated aberration coefficient indicates a decline in retinal image quality. Zernike Analysis makes it possible to determine the exact position of the keratoconus apex.

# OCULUS Floating License Key

## Activate Functions Exactly as you Need Them

The Floating License Key activates optional functions in the device software. You only require one Floating License Key which centrally manages all licenses in a local network. You can decide which additional functions are to be allocated to each device.

## Efficiency Through Networking

The OCULUS patient data management enables you to merge all OCULUS devices in a local network. It allows you to network with external data management systems (EMR) to optimises your workflows. Devices with or without DICOM interface can be connected. Subtasks can be easily delegated and datasets can be centrally managed.

